



KERNLOCHBOHRER[®]
PROFESSIONAL POWER TOOLS



Operating instructions
Floor grinding machine
BSM-250/E-PRO

BA-02-000001-01-EN

Scope of application

These Operating instructions only apply to the machine labelled on the cover sheet.

Check the machine model using the machine's rating plate.

Original instructions / translation of the original instructions

In accordance with the EU Machinery Directive, the German copy of these Operating instructions is the original instructions.

Copies in other languages are translations of the original instructions.

Kernlochbohrer GmbH

Geigersbühlweg 52

72663 Großbettingen

Germany

Phone: +49 (0)70 22 / 50 34 900

E-mail: info@kernlochbohrer.com

Internet: <http://www.kernlochbohrer.com>

© Kernlochbohrer GmbH

This documentation is protected by copyright.

All rights to this documentation, in particular the right of reproduction, distribution and translation, are reserved by Kernlochbohrer GmbH, even in the case of applications for industrial property rights. No part of this documentation may be reproduced in any form by any means, electronic or mechanical, or processed, duplicated or distributed using electronic systems without the express written permission of Kernlochbohrer GmbH.

Errors and technical changes excepted.

Kernlochbohrer GmbH is not liable for any errors in this documentation. Liability for direct or indirect damages arising in connection with the delivery or use of this documentation is excluded to the extent permitted by law. Furthermore, Kernlochbohrer GmbH cannot be held liable for damages resulting from the infringement of patent and other rights of third parties.

The function of the machine is limited to the functions described in the associated technical documentation.

Table of contents

1	Information and support	7
1.1	Thanks to the buyer.....	7
1.2	Using the Operating instructions	7
1.3	Changes	7
1.4	Explanation of symbols	8
1.5	Guarantee	8
1.6	Environmental protection.....	9
1.6.1	Disposal of the product.....	9
1.6.2	Disposal of the packaging	9
1.7	Service	10
2	Security.....	11
2.1	General information.....	11
2.2	Intended use.....	12
2.3	Safety regulations for the operator.....	13
2.3.1	Organisational safety measures	13
2.3.2	Changes to the machine.....	13
2.3.3	Spare parts	14
2.3.4	Personnel.....	14
2.4	Safety regulations for staff.....	15
2.4.1	Safe behaviour.....	15
2.4.2	Safe operation	16
2.4.3	Protective equipment.....	17
2.5	Safety during maintenance.....	18
2.5.1	General information	18
2.5.2	Cleaning.....	18
3	Technical data	19
4	Machine description	20
4.1	Machine components	20
4.2	Operating devices	22
4.2.1	Starter box	22

4.2.2	Grinding head adjustment	24
4.2.3	Level adjustment.....	25
4.2.4	Corner wheel setting.....	27
4.2.5	Guide arm adjustment	28
4.3	Other interfaces	30
4.3.1	Connection for water supply	30
4.3.2	Connection for dust extraction.....	32
4.4	Maintenance position	34
4.5	Scope of delivery	36
5	Utilisation of the machine	37
5.1	Specific precautions	37
5.2	Unpacking the machine.....	38
5.3	Transport of the machine	39
5.4	Working with the machine	40
5.4.1	Visual inspection of the machine	40
5.4.2	Mounting the grinding tool	41
5.4.3	Electrical connection.....	42
5.4.4	Using the machine	43
5.4.5	Switch off the machine.....	46
5.4.6	Store the machine.....	46
6	Maintenance.....	47
6.1	Notes on proper maintenance.....	47
6.2	Maintenance and inspection plan.....	47
6.3	Inspection and maintenance	48
6.3.1	Clean the machine and check	48
7	Troubleshooting.....	51
8	Spare parts	52
9	EU Declaration of Conformity.....	54

1 Information and support

1.1 Thanks to the buyer

Thank you for purchasing a machine from Kernlochbohrer GmbH.

Please read the Operating instructions carefully and observe the safety instructions. By following the Operating instructions, you will be able to fully utilise the outstanding performance of our product.

If you have any questions regarding the operation of the machine, please contact Kernlochbohrer GmbH directly. We are available to answer your questions at any time.

1.2 Using the Operating instructions

The machine is intended for professional use and may only be operated by trained personnel. Strictly adhere to the instructions in the Operating instructions.

Our company declines all responsibility in the event of non-compliance with the Operating instructions, which may result in injury or damage to the machine.

The Operating instructions are indispensable for using the machine. The Operating instructions must therefore always be kept close to the machine and be accessible to the intended personnel at all times.

In addition to the Operating instructions, the generally applicable and local regulations for accident prevention and environmental protection must be provided; compliance with these regulations must be checked regularly.

1.3 Changes

Kernlochbohrer GmbH reserves the right to change the design and appearance of the products and their Operating instructions. Future changes to the Operating instructions will be made without prior notice.

1.4 Explanation of symbols



The symbol draws your attention to dangers that you must be aware of when carrying out the following work in order to avoid injury to yourself, other persons or damage to property.



Cross-reference to another point in the Operating instructions.



Prerequisite for an action.



Action to be performed.



Behaviour of the machine that is to be expected as a result of the preceding action.



Background information or reference to special features.

1.5 Guarantee

In accordance with Kernlochbohrer GmbH's general terms of delivery, a warranty period of 12 months applies to material defects in business transactions with companies (proof by invoice or delivery note).

Damage caused by natural wear and tear, overloading or improper handling is excluded.

Damage caused by material or manufacturer defects will be rectified free of charge by repair or replacement. Complaints can only be recognised if the device is sent to Kernlochbohrer GmbH undismantled.

Wear parts are excluded from the warranty.

1.6 Environmental protection

1.6.1 Disposal of the product

Follow national regulations on environmentally friendly disposal and recycling of used machines and accessories.

For EU countries only:

Do not dispose of the machine with household waste! In accordance with European Directive 2012/19/EU on waste electrical and electronic equipment and its transposition into national law, used power tools must be collected separately and recycled in an environmentally friendly manner.

1.6.2 Disposal of the packaging

The packaging is made from recyclable materials. They must be disposed of in accordance with their labelling and municipal guidelines.

1.7 Service

Precise information and specific questions allow faults to be rectified quickly, make it easier to order spare parts and prevent incorrect deliveries.

Before contacting the service, please collect the following data first.

The model designation must be stated in all enquiries and orders. This information can be found on the rating plate of the machine.

In the event of malfunctions, further information is required: type and extent of the malfunction, accompanying circumstances, suspected cause.

When ordering spare parts, the following is required: Quantity and item number in the exploded drawing in these Operating instructions.

Contact details:

Kernlochbohrer GmbH

Geigersbühlweg 52

72663 Großbettlingen

Germany

Phone: +49 (0)70 22 / 50 34 900

E-mail: info@kernlochbohrer.com

Internet: <http://www.kernlochbohrer.com>

2 Security

2.1 General information

The machine was built according to the state of the art and in compliance with the applicable laws, standards and safety regulations. Nevertheless, the use of the machine can result in hazards for the user or third parties as well as damage to the machine and other property.

The machine may only be used if it is in perfect working order and in accordance with its intended use and in a safe and hazard-conscious manner.

If the machine is damaged or malfunctions, switch it off immediately, secure it against being switched on again and repair it or arrange for it to be repaired.

2.2 Intended use

The machine is designed exclusively for grinding floor surfaces.

The machine can be used for the following purposes:

- Grinding and processing of uneven floors such as adhesive residues or coatings.
- Renovation of sealed surfaces.
- Preparation of hard floors or asphalt.

Floor surfaces can be grinded using the dry or wet method:

- If the dry method is used, the resulting grinding dust must be removed using a suitable industrial Hoover.
- A water supply can be connected to the machine for wet grinding of floor surfaces.

The machine may only be used within the limits of its technical data. This information, for example performance data and ambient conditions, can be found in the "Technical data" chapter.

Any other or additional use is considered improper use - risk of accident!
Kernlochbohrer GmbH is not liable for any resulting damage. The risk is borne solely by the operator.

Intended use also includes observing the operating instructions and complying with the prescribed maintenance intervals.

2.3 Safety regulations for the operator

2.3.1 Organisational safety measures

The Operating instructions must always be available for the operating and maintenance personnel. It must therefore always be kept at the machine's place of use.

The regulations on accident prevention and environmental protection applicable at the machine's place of use must also be available. The operator of the machine must regularly check compliance with these regulations.

The use of sound-emitting machines may be limited in time by national or local regulations.

The machine must not be operated in potentially explosive atmospheres.

All safety and danger notices on the machine must be legible and must not be removed.

The protective equipment required to operate the machine must be provided by the operator. The operator must ensure that the protective equipment is used properly by the personnel.

Operating and auxiliary materials, such as lubricants or cleaning agents, must be selected in such a way that the limit values for hazardous substances applicable at the place of use are complied with. The regulations for environmental protection and disposal applicable at the place of use must be complied with.

2.3.2 Changes to the machine

The operator may not make any modifications to the machine without written authorisation from Kernlochbohrer GmbH. If the operator carries out modifications without authorisation, the warranty becomes void. Kernlochbohrer GmbH is not liable for damage caused by unauthorised modifications.

2.3.3 Spare parts

Spare parts must comply with the properties defined by Kernlochbohrer GmbH. This is always guaranteed for spare parts supplied by Kernlochbohrer GmbH. Kernlochbohrer GmbH is not liable for damage caused by the use of unsuitable spare parts.

2.3.4 Personnel

All persons who are authorised to commission, operate and maintain the machine must have read and understood the Operating instructions beforehand.

The machine may only be operated by persons who have been adequately instructed beforehand.

The machine may only be serviced by persons who have completed the appropriate specialised training for this activity.

Minors are not permitted to work with the machine. Young people over the age of 16 who are trained under supervision are exempt from this regulation.

2.4 Safety regulations for staff

2.4.1 Safe behaviour

All persons responsible for commissioning, operating and maintaining the machine must have read and understood the Operating instructions beforehand.

The machine may only be operated by persons who have been adequately instructed beforehand.

The machine may only be serviced by persons who have completed the appropriate specialised training for this activity.

Minors are not permitted to work with the machine. Young people over the age of 16 who are trained under supervision are exempt from this regulation.

Any work on and with the machine that could jeopardise safety must be avoided.

All safety and danger notices on the machine must be legible and must not be removed.

2.4.2 Safe operation

Operating the machine requires the full concentration and ability of the personnel. Persons who are overtired, unable to concentrate or under the influence of alcohol, drugs or medication must not work on or with the machine.

Persons who are not directly required to operate the machine must maintain a sufficient safety distance from the machine.

Before using the machine, check that it is in perfect condition. If the machine is damaged, it must not be used. Then secure the machine against use and repair it or arrange for it to be repaired.

In order not to jeopardise the functionality and safety of the machine, covers or other components of the machine must not be removed.

Before starting or starting up the machine, ensure that persons are not endangered by the starting machine.

Operating elements must not be operated thoughtlessly or wilfully. This could result in personal injury or damage to the machine.

When using the machine, personnel must ensure that they are standing securely and in an ergonomic posture. The machine must always be held with both hands.

The machine must not be left unattended during use.

Stopping the machine during operation with a heavy load must be avoided. This could lead to damage due to overheating.

Air inlet and outlet openings must not be covered during use.

Never immerse the machine in water.

The machine must be cleaned regularly so that dirt does not accumulate. All operating elements and handles must be kept clean, dry and free of grease.

When the machine is not in use, it must be parked in such a way that nobody is endangered. Secure the machine against unauthorised use.

2.4.3 Protective equipment

Persons using the machine are obliged to wear the following protective equipment:

- Safety shoes with non-slip sole and protective toe cap.
- Safety goggles according to standard EN 166 or face protection.
- Cut-resistant and non-slip gloves.



Silica is a basic component of sand, quartz, brick clay, granite and numerous other materials and rocks.

Grinding materials containing silica can produce dust and aerosols containing crystalline silica.

Repeated and/or significant inhalation of crystalline silica may cause severe or fatal respiratory illness.

The generation of harmful grinding dust must be prevented by technical means (wet process or dry process with dust extraction). If this is not possible, the operating personnel and bystanders must always wear a respirator approved for the material being processed.

If the noise emissions generated when using the machine exceed the limit values applicable to this workplace, suitable hearing protection must be worn.

Loose-fitting clothing, long hair or body jewellery can get caught on moving parts of the machine!

Persons carrying out maintenance work on the machine are obliged to wear the appropriate protective equipment required for this work.

2.5 Safety during maintenance

2.5.1 General information

The machine may only be serviced by persons who have completed the appropriate specialised training for this activity.

The maintenance activities and intervals specified in the Operating instructions must be observed.

Workshop equipment appropriate to the type of work is required to carry out maintenance activities.

The following safety precautions must be taken before starting maintenance work:

- Position the machine so that the surgical site is easily accessible.
- Set the machine to the corresponding operating status.

After completion of maintenance activities:

- Assemble the machine completely.
- If operating elements or safety devices have been removed, they must be refitted and their function checked.
- Retighten loosened screw connections. Re-apply the screw locks.

Persons carrying out maintenance work on the machine are obliged to wear the appropriate protective equipment required for this work.

2.5.2 Cleaning

Do not use any corrosive, harmful or environmentally damaging substances to clean the machine.

Dispose of cleaning agents in an environmentally friendly manner.

Under no circumstances should high-pressure cleaners, water jets or compressed air be used to clean the machine.

3 Technical data

Article number	6232
Maximum working width	Grinding head Ø 250 mm
Power consumption	2200 W
Power supply	230 V ±5% / 50 Hz
Rated speed	1400 1/min
Main construction	Powder-coated steel
Plate type	Standard / 10 inch
Length	1200 mm
Width	340 mm
Height	830 mm
Weight	55.7 kg
Permissible ambient temperature	5°C to 40°C
Permissible relative humidity	30% to 80%
Protection class	IP 54
Connector plug	Type F (CEE 7/4)
Required connection cable	H05RN-F 3G 2.5 or H05BQ-F 3G 2.5 or better
Sound power level L_{weq}	60 dB(A)
Hand/arm vibration according to EN 61029	< 2.5 m/s ²
Water supply connection	Gardena
Dust extraction connection	D = 49,5 mm / d = 45 mm

4 Machine description

4.1 Machine components

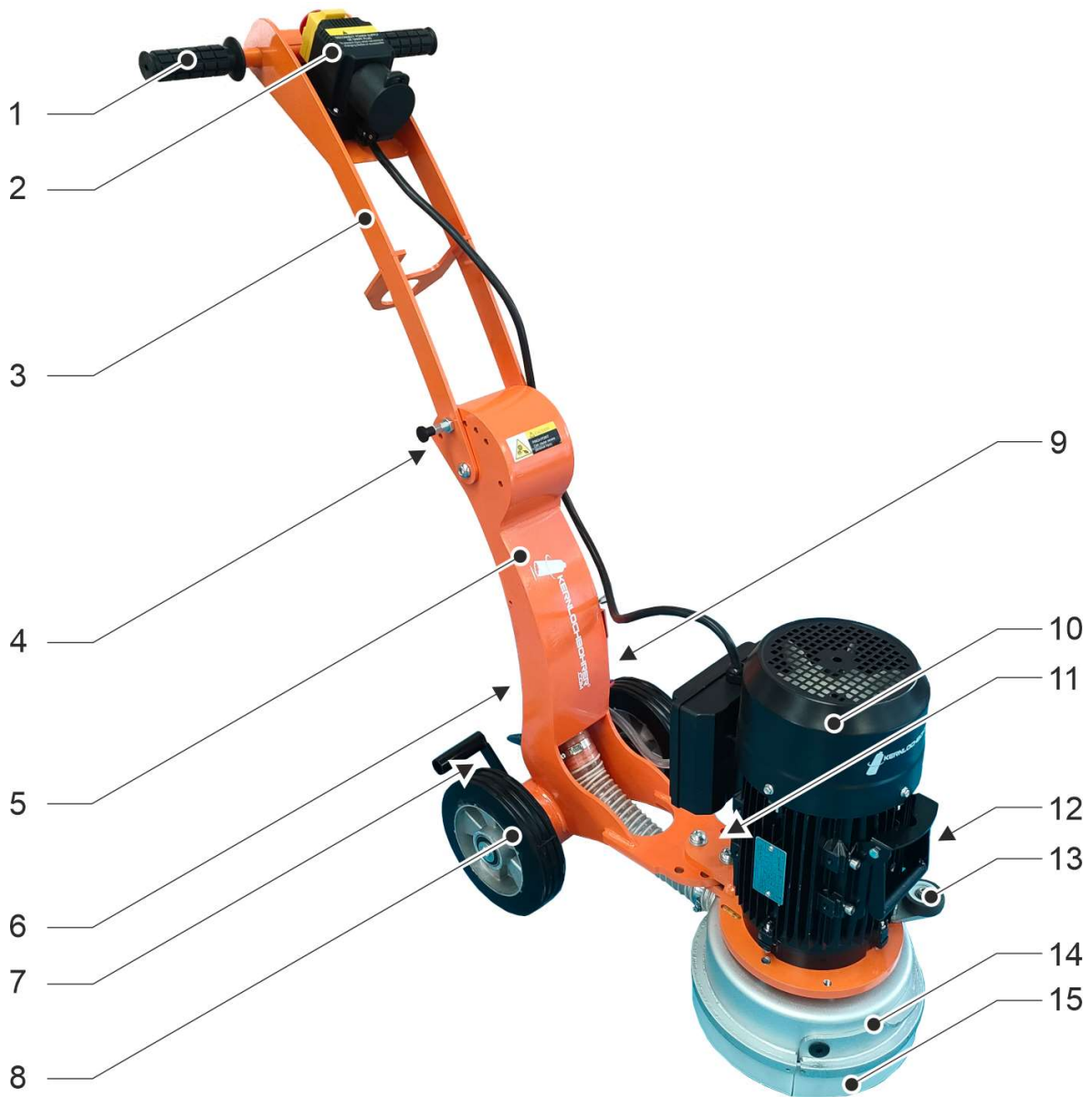

Machine components

- 1 Handle (2 pieces)
- 2 Starter box
- 3 Upper part of guide arm
- 4 Guide arm adjustment
- 5 Lower part of guide arm
- 6 Connection of the dust extraction system
- 7 Level adjustment
- 8 Wheel (2 pieces)
- 9 Connection of the water supply
- 10 Drive motor
- 11 Grinding head adjustment
- 12 Folding transport handle
- 13 Corner wheel
- 14 Grinding head
- 15 Dust cover (two-piece)

4.2 Operating devices

4.2.1 Starter box

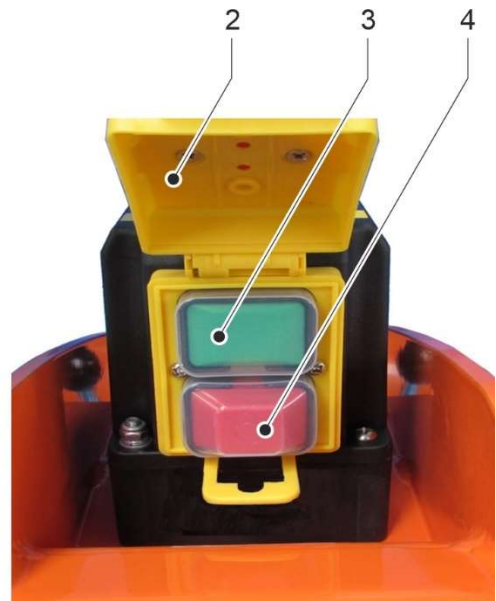

Starter box

- 1 Connector plug
- 2 Emergency stop flap
- 3 Start button
- 4 Stop button

Connector plug

The machine is connected to the power supply using the connector plug.

A connection cable of type H05RN-F 3G2.5, H05BQ-F 3G2.5 or better with a socket (CEE 7/3) must be used for this purpose.

Emergency stop flap

The emergency stop flap is used to quickly switch off the machine in an emergency or dangerous situation.



After switching off the drive motor by closing the emergency stop flap or pressing the stop button, the grinding tool continues to rotate for a while.

Keep your distance from the grinding tool until the grinding tool has come to a complete standstill.

To open the flap, push the red release button upwards, the flap is then unlocked and can be opened.

To close the flap, press down on the release button until it clicks into place.

Start and stop button

The start and stop buttons are located under the emergency stop flap.

To open the flap, push the red release button upwards, the flap is then unlocked and can be opened.

The machine is switched on by pressing the start button. The emergency stop flap must not be closed afterwards, as this would switch off the machine.

The machine is switched off by pressing the stop button.



After switching off the drive motor by closing the emergency stop flap or pressing the stop button, the grinding tool continues to rotate for a while.

Keep your distance from the grinding tool until the grinding tool has come to a complete standstill.

To close the flap, press down on the release button until it clicks into place.

4.2.2 Grinding head adjustment

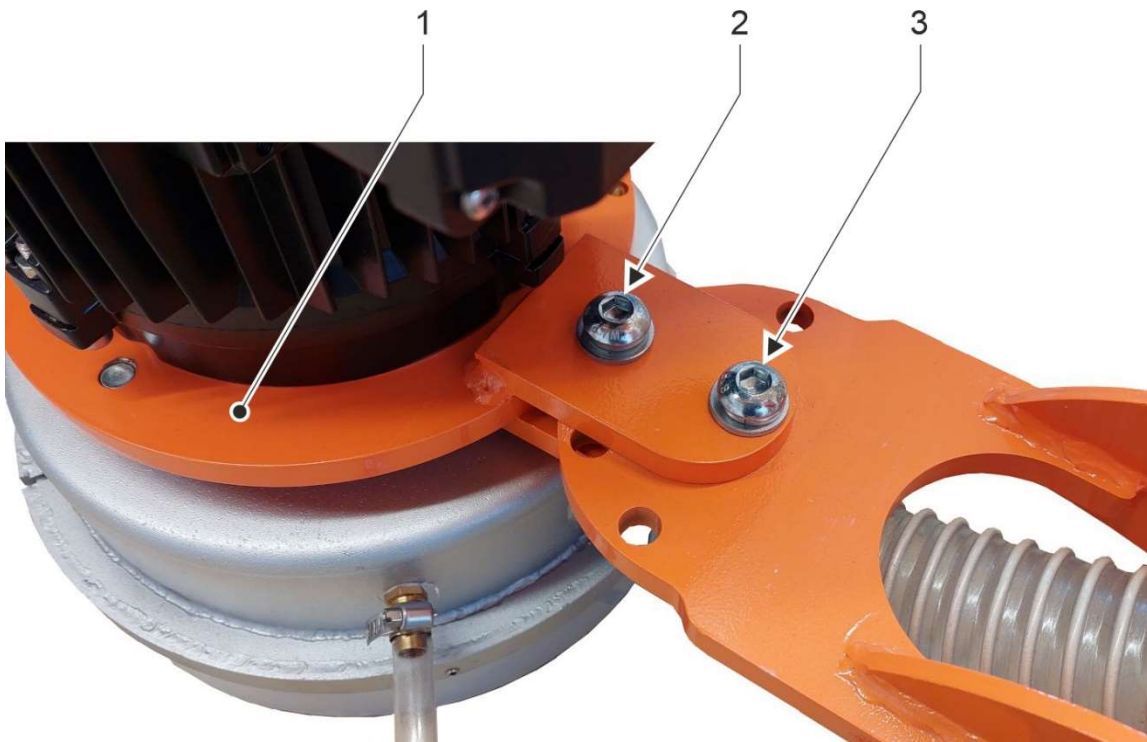

Grinding head adjustment

- 1 Grinding head
- 2 Front locking screw
- 3 Rear locking screw

The grinding head can be adjusted from the centre of the chassis for working close to the edge:

- Remove the front locking screw of the grinding head adjustment.
- Loosen the rear locking screw.
 - ↪ The grinding head can now be rotated.
- Fully screw in both locking screws of the grinding head adjustment.



Always screw in both locking screws of the grinding head adjustment completely so that the grinding head is securely fixed!

Do not transport or use the machine without a fixed grinding head!

4.2.3 Level adjustment

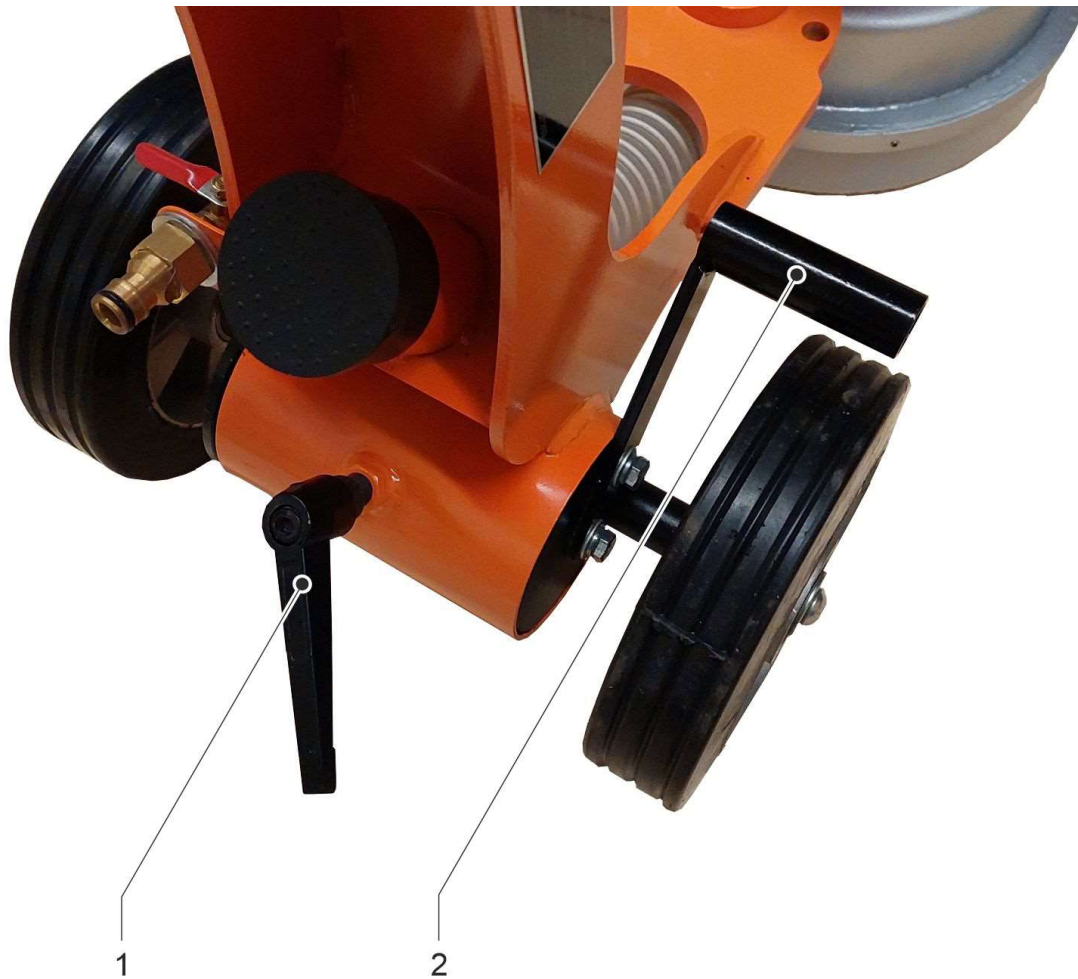

Level adjustment

- 1 Clamping lever
- 2 Level adjustment handle

The level adjustment of the grinding head serves to equalise the different heights when using different types of tools:

- Hold the level adjustment handle.
- Release the level adjustment clamping lever.
 - ↪ The position of the grinding head can now be changed by raising or lowering the level adjustment handle.

- ☒ The rear end of the machine is raised by lifting the levelling handle.
The rear end of the machine is lowered by lowering the level adjustment handle.
- The horizontal position of the grinding head can be checked on the level.
- ☒ Tighten the level adjustment clamping lever.

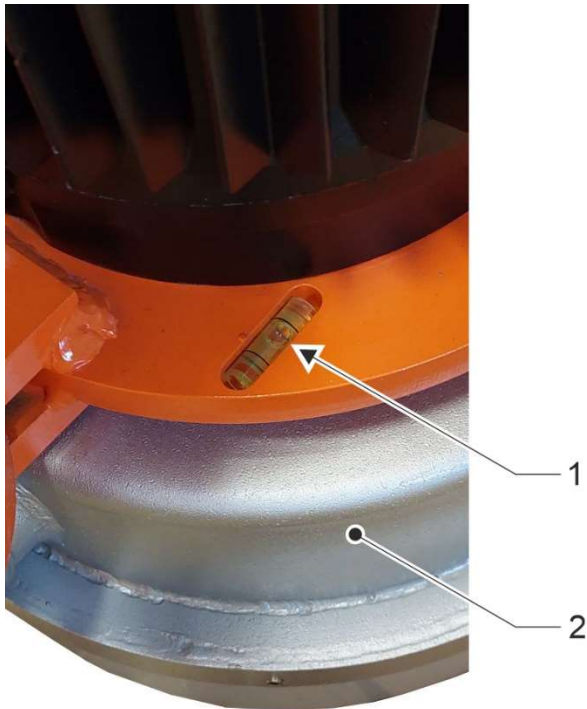

Level adjustment

- 1 Dragonfly
- 2 Grinding head



Always tighten the level adjustment clamping lever so that the grinding head is securely fixed!

Do not transport or use the machine without a fixed grinding head!

4.2.4 Corner wheel setting



Corner wheel setting

- 1 Corner wheel
- 2 Fixing screw of the corner wheel

The position of the corner wheel can be adjusted:

- Loosen the fastening screw.
 - ↪ The corner wheel can be adjusted.
- Tighten the fastening screw.



Always tighten the fastening screw so that the corner wheel is securely fixed!

4.2.5 Guide arm adjustment

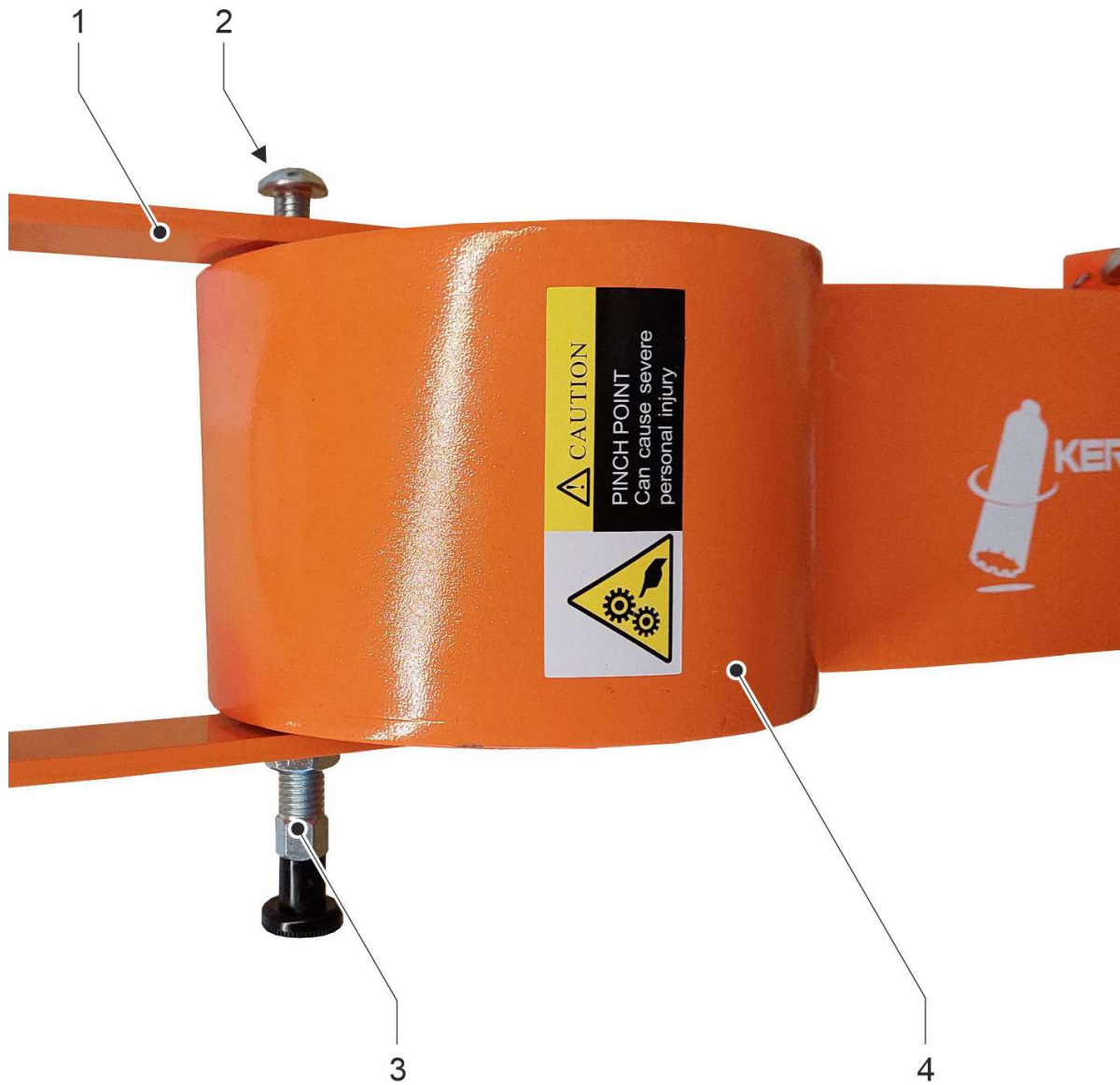

Guide arm adjustment

- 1 Upper part of guide arm
- 2 Locking screw
- 3 Spring bolt
- 4 Lower part of guide arm

The guide arm can be folded in for transporting the machine:

- ☒ Unscrew the locking screw of the guide arm until it no longer engages in the lower part of the guide arm.
- ☒ Hold the upper part of the guide arm.
- ☒ Pull out the spring latch.
 - ↪ The upper part of the guide arm can now be twisted.
- ☒ Fully screw in the locking screw.
 - ↪ The upper part of the guide arm is now securely fixed.



Always screw in the locking screw completely so that the upper part of the guide arm is securely fixed!

Do not transport or use the machine without the upper part of the guide arm fixed!

4.3 Other interfaces

4.3.1 Connection for water supply



Health hazard!

Wherever possible, floor surfaces must be grinded using the wet method to avoid the formation of harmful grinding dust.

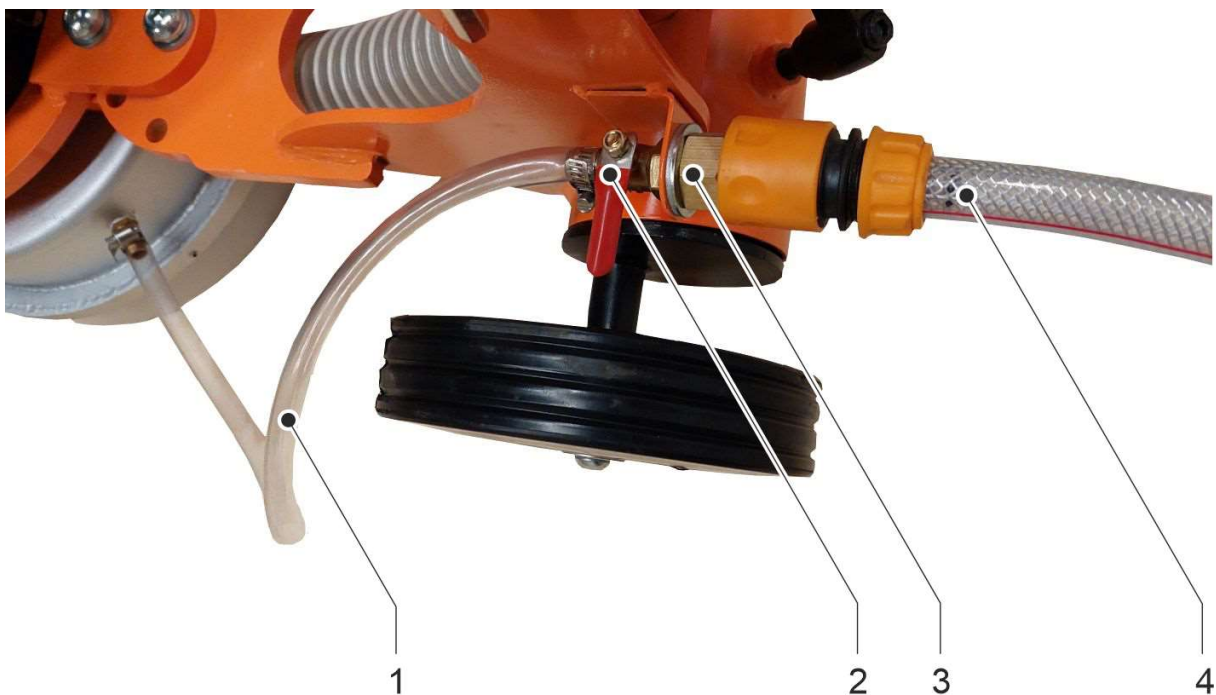

Connection for water supply

- 1 Hose to the grinding head
- 2 Ball valve
- 3 Connection piece
- 4 Water hose with Gardena coupling

If the machine is to be used in a wet process, the water supply must be established.

To do this, connect a water hose with a Gardena quick-release coupling to the connector on the machine.

The ball valve can be used to stop the water supply completely or to regulate the water flow.

- ① Kernlochbohrer GmbH recommends the use of our WT-35/P-PRO water tank to supply the machine with water.

4.3.2 Connection for dust extraction



Health hazard!

If floor surfaces cannot be grinded using the wet method, the harmful grinding dust generated during the dry process must be extracted using a suitable industrial Hoover.

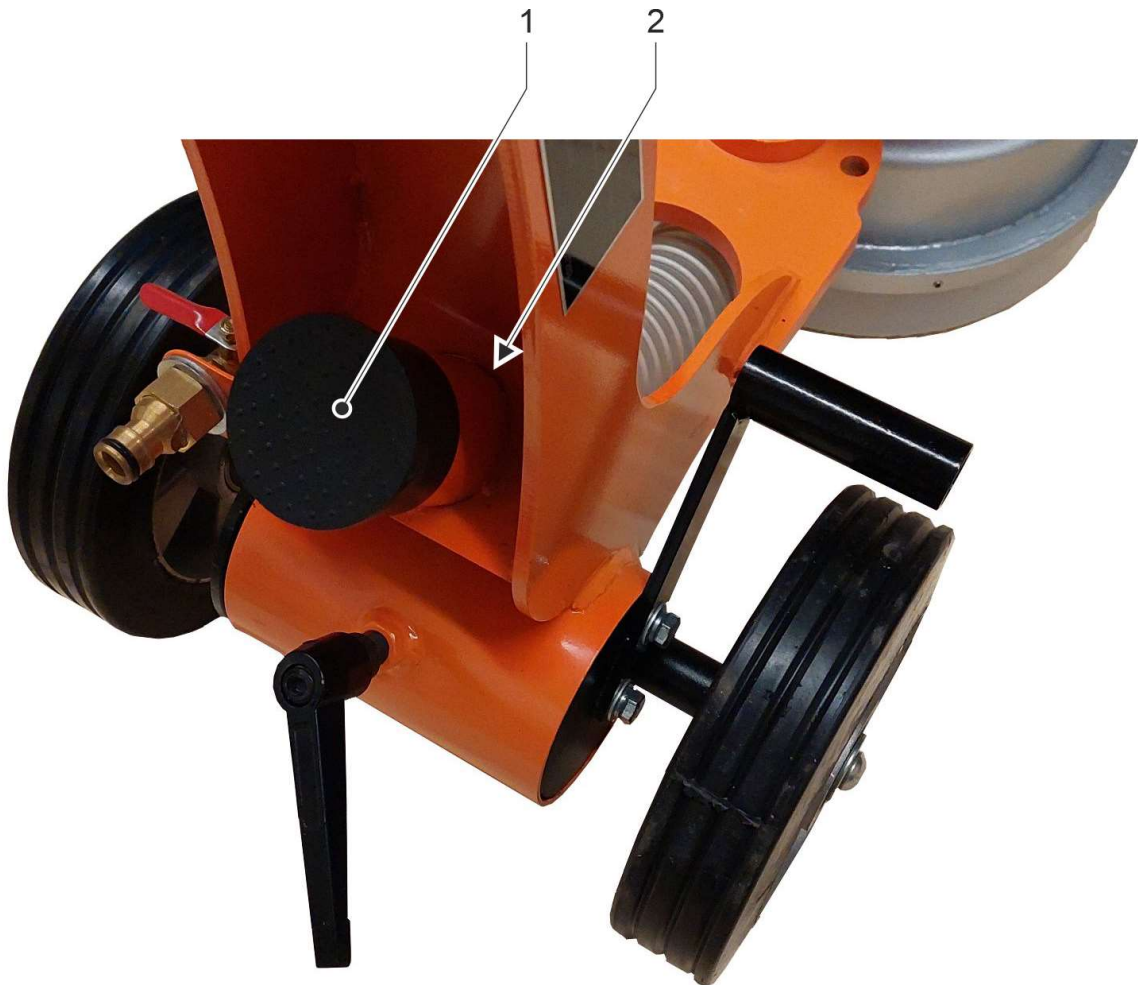

Connection for dust extraction

- 1 Dust cover
- 2 Dust extraction pipe

If the machine is to be used in a dry process, the grinding dust must be extracted.

To do this, connect an industrial Hoover to the dust extraction pipe (D = 49,5 mm / d = 45 mm) of the machine.

- ① Kernlochbohrer GmbH recommends the use of our TS-1000/PRO industrial dry vacuum cleaner for dust extraction.

If the machine is not connected to an industrial Hoover, the dust extraction pipe must be closed with the dust protection cap.

4.4 Maintenance position

The machine can be brought into a maintenance position for work on the underside of the grinding head.



Machine in maintenance position

- 1 Wheel
- 2 Grinding head
- 3 Level adjustment clamping lever
- 4 Joint of the guide arm

Procedure:

- ☑ Machine switched off.
 - 📖 See chapter 5.4.5 "Switch off the machine".
- ☑ Power cable socket removed from connector plug.
 - 📖 See chapter 5.4.3 "Electrical connection".
- ☑ Water supply or dust extraction disconnected.
 - 📖 See chapter 4.3 "Other interfaces".
- ☑ Turn the level adjustment clamping lever so that it rests against the dust extraction pipe. Otherwise, the clamping lever may be damaged when the machine is tilted.
 - 📖 See chapter 4.2.3 "Level adjustment".
- ☑ Move the upper part of the guide arm to the horizontal position and secure it.
 - 📖 See chapter 4.2.5 "Guide arm adjustment".
- ☑ Tilt the machine backwards over the wheels so that the joint of the guide arm rests on the ground.
 - 👉 The underside of the grinding head is accessible.



Machine in maintenance position - underside of the grinding head is accessible

4.5 Scope of delivery

The scope of delivery of the machine includes the following components:

- Floor grinding machine
- Dust protection belt
- 4 countersunk screws M12x25 for fastening the grinding tool (grinding disc or adapter plate)
- Allen key SW 8
- Allen key SW 2.5
- Operating instructions

- ① The grinding tool required to use the machine must be purchased separately.

There are various options for this:

- Adapter plate Ø 250 mm for equipping with grinding shoes or grinding pads.
- Grinding disc Ø 250 mm.

Kernlochbohrer GmbH offers an extensive range of tools and accessories for the machine. The webshop <http://www.kernlochbohrer.com> is available for information and ordering.

- ① The dust protection belt supplied with the machine can be attached to the grinding head in addition to the dust protection already fitted.

Alternatively, Kernlochbohrer offers a dust protection brush rim for the grinding head. The webshop <http://www.kernlochbohrer.com> is available for information and ordering.

- ① The holder for the two Allen keys is located on the lower part of the guide arm.

5 Utilisation of the machine

5.1 Specific precautions



Floor surfaces can be grinded using the dry or wet method:

Wherever possible, the wet process must be used to avoid the formation of harmful grinding dust.

If the dry method is used, the resulting grinding dust must be removed using a suitable industrial Hoover.

To avoid damage or overloading, do not place any objects on the machine.

If a fault occurs during operation of the machine (e.g. smell of burning), switch off the machine immediately and disconnect the mains cable from the plug. Otherwise a fire, electric shock or other incident could occur. The machine may only be switched on again once the fault has been rectified and the machine is functioning correctly.

5.2 Unpacking the machine



Machine in transport crate



The upper part of the machine's guide arm was folded all the way forwards for despatch from the manufacturer to the customer. It cannot be fixed in this position.

Before lifting the machine, first securely fix the upper part of the machine's guide arm.



See chapter 4.2.5 "Guide arm adjustment".

5.3 Transport of the machine

Before transporting the machine:

- Switch off the machine.
- Remove the mains cable from the connection plug.
- Disconnect the water supply or dust extraction system.

The upper part of the guide arm can be folded in for transporting the machine:



See chapter 4.2.5 "Guide arm adjustment".



Always securely fasten the upper part of the machine's guide arm for transport.



The foldable transport handle on the drive motor can also be used to transport the machine.



See chapter 4.1 "Machine components".

After transporting the machine, switch it off again and secure it against falling over.

5.4 Working with the machine

5.4.1 Visual inspection of the machine

Before working with the machine, it must be visually inspected:

- Check the general condition and cleanliness of the machine.
- Check that all covers and machine components are present.
- Dust guard present on the grinding head and effectively attached.
- If applicable, the dust protection belt supplied or optionally available dust protection brush rim is present on the grinding head and effectively attached.
- Check the tightness of all screws.
- Air inlet and outlet openings must not be dirty or covered.
- The mains cable and connection plug must not be damaged.

5.4.2 Mounting the grinding tool

Before working with the machine, the grinding tool must be mounted on the grinding head.

There are various options for this:

- Mounting an adapter plate. Various grinding or polishing pads can then be mounted on the adapter plate.
- Mounting a grinding disc.

Pay attention to the following points for optimum results:

- Suitability of the grinding tool for the material to be processed.
- Correct balance quality of the grinding tool.
- Check the condition and correct assembly of the grinding tool. Never use damaged grinding tools.

The grinding tool is mounted on the grinding head using the four M12x25 countersunk screws supplied.

Tighten the countersunk screws to a torque of 70 Nm.

To fit the grinding tool, bring the machine into the maintenance position.



See chapter 4.4 "Maintenance position".

5.4.3 Electrical connection

Please note the following points:

- Comply with the electrical connection values of the appliance.
 See chapter 3 "Technical data".
- The mains cable and connection plug must not be damaged.
- Damaged connectors may only be replaced by Kernlochbohrer GmbH or a qualified electrician.
- The mains cable socket and plug must be clean and dust-free.
- The supplied electrical voltage must not deviate by more than 5% from the nominal value. Excessive voltages can lead to irreparable damage to the machine.
- When operating the machine with power generators, voltage peaks must not occur.
- When connecting the machine to the mains, a residual current device (RCD) with a maximum tripping current of 30 mA must be connected upstream.
- The machine is equipped with a type F lug (CEE 7/4). The machines may only be operated using a mains cable with the corresponding socket (CEE 7/3).
- The mains cable must be of type H05RN-F 3G2.5, H05BQ-F 3G2.5 or better.
- When using extension cables, the cable cross-section must be suitable for the power consumption of the machine.
- When using a cable reel, the cable must always be unrolled completely.
- To remove the mains cable from the plug, grip the socket. Do not pull on the cable.
- If the machine is not to be used for a longer period of time, switch off the machine and remove the plug from the socket.





5.4.4 Using the machine







The generation of harmful grinding dust must be prevented by technical means (wet process or dry process with dust extraction).

If this is not possible, the operating personnel and bystanders must always wear a respirator approved for the material being processed.

Prerequisites:

- ☑ Visual inspection of the machine carried out.
 See chapter 5.4.1 "Visual inspection of the machine".
- ☑ Grinding tool mounted.
 See chapter 5.4.2 "Mounting the grinding tool".
- ☑ Water supply established or dust extraction system connected and switched on.
 See chapter 4.3 "Other interfaces".
- ☑ Electrical connection of the machine established.
 See chapter 5.4.3 "Electrical connection".

Procedure:

- ☒ Place the machine on the floor surface to be worked.
- ☒ Guide arm adjusted and fixed at an ergonomically sensible height.
 See chapter 4.2.5 "Guide arm adjustment".
- ☒ If necessary, adjust the level of the grinding head.
 See chapter 4.2.3 "Level adjustment".
- ☒ Adjust the grinding head if necessary.
 See chapter 4.2.2 "Grinding head adjustment".
- ☒ Adjust the corner wheel if necessary.
 See chapter 4.2.4 "Corner wheel setting".

- ☒ To lower the pressure of the grinding head onto the floor surface: Hold the guide arm by the handles and press down.



The fast-rotating grinding tool is located on the underside of the grinding head when the machine is switched on.

Do not lift the grinding head off the floor, only relieve it.

- ☒ Start the machine's drive motor. To do this, press the start button.
 - ↪ The drive motor is switched on.
- ☒ When the machine has reached its rated speed: Check the emergency stop function of the machine
 - ☒ Close the emergency stop flap.
 - ↪ The drive motor is switched off.
 - ☒ Check whether the drive motor stops.

If the drive motor is not switched off after closing the emergency stop flap, have the machine repaired by Kernlochbohrer GmbH or a qualified electrician. Do not operate the machine in this condition!
 - ☒ Unlock and open the emergency stop flap.
- ☒ Start the machine's drive motor. To do this, press the start button.
- ☒ When the machine has reached its rated speed:
 - ☒ Lower the grinding head onto the floor surface to be processed.
 - ☒ To produce an evenly grinded surface, move the grinding head back and forth continuously until the desired result is achieved.

- ① Always check the grinding tool and dust protection during processing!

Procedure:

- ☒ Switch off the machine. To do this, press the stop button.
- ☒ Remove the mains cable socket from the connector plug.
- ☒ Check the condition and fastening of the grinding tool.
- ☒ Replace damaged or worn grinding tools.
- ☒ Check the condition and effectiveness of the dust guard on the grinding head. Replace damaged or worn dust protection.

5.4.5 Switch off the machine

Procedure:

- ☒ Press the stop button.
 - ☞ The drive motor is switched off.
- ☒ Remove the mains cable socket from the connector plug.
- ☒ Check the machine for soiling. Clean the machine if necessary.
 - 📖 See chapter 6.3.1 "Clean the machine and check".

5.4.6 Store the machine

Procedure:

- ☒ Machine switched off.
 - 📖 See chapter 5.4.5 "Switch off the machine".
- ☒ Clean the machine and allow to dry completely.
 - 📖 See chapter 6.3.1 "Clean the machine and check".
- ☒ Park the machine vertically and secure it against falling over.
- ☒ Store the machine in a dry, cool place protected from moisture and direct sunlight.
- ☒ Secure the machine against unauthorised use.

6 Maintenance

6.1 Notes on proper maintenance

Insufficient or improper maintenance can cause malfunctions and impair the operational safety and service life of the machine. Regular inspection and maintenance is therefore essential. We recommend that maintenance work is only carried out by trained personnel.

The contractually agreed warranty does not release the operator of the machine from the obligation to maintain the machine in accordance with the manufacturer's instructions from the time of commissioning. Kernlochbohrer GmbH is not liable for damage caused by a lack of maintenance.

6.2 Maintenance and inspection plan

The interval specifications refer to normal operating conditions. In more difficult conditions (heavy dust accumulation, etc.) and longer daily working times, the specified intervals must be shortened accordingly by the operator.

Use the maintenance and inspection schedule only as a guide! Be sure to follow the cross-references to the other chapters! They describe in detail how to carry out the individual tasks correctly and safely.

Interval	Category	Component	Activity	Chapter
1 day	Real time	Machine	Cleaning and checking	6.3.1

6.3 Inspection and maintenance

6.3.1 Clean the machine and check



Do not use sharp sponges or metal objects to clean the machine. These could damage the surface of the machine.

Do not use high-pressure cleaners, water jets or compressed air to clean the machine. The sharp water or air jet could damage the machine.

No corrosive, harmful or environmentally damaging substances may be used to clean the machine.

Interval:

1 day real time

Auxiliary means:

- The cleaning agent should be placed in a container with a mixture of water and mild detergent (e.g. washing-up liquid).
- Cloth and brush

Procedure:

- Switch off the machine and remove the power cable socket from the connector plug.
 -  See chapter 5.4.5 "Switch off the machine".
- Clean the machine to remove dust and dirt.
 - Use a damp cloth dipped in water mixed with a mild detergent.
 - Water must not be allowed to enter the interior of the drive motor via the air inlet and outlet openings.

- ☒ Clean the air inlet and outlet openings of the drive motor with a brush and damp cloth.
- ☒ Allow the machine to dry completely.
- ☒ Check that all screws on the machine are tight. If necessary, tighten the screws.
- ☒ Check the condition and effectiveness of the dust guard on the grinding head. Replace damaged or worn dust protection.
- ☒ If necessary, check the condition and effectiveness of the dust protection belt on the grinding head. Replace damaged or worn dust protection belt.
- ☒ If necessary, check the effectiveness of the dust protection brush rim on the grinding head. Replace damaged or worn dust protection brush rim.

7 Troubleshooting

If a fault occurs during operation of the machine, please first try to rectify the fault yourself using the following information.

If you are unable to rectify the fault yourself, please contact Kernlochbohrer GmbH.

Malfunction	Possible cause	Troubleshooting
Grinding disc rotates, but does not provide the required power	Grinding tool is not matched to the application	Replacing the grinding tool
Machine vibrates during operation	Grinding tool not correctly balanced	Replacing the grinding tool
Grinding noise from the grinding head when idling	Motor bearing or drive coupling worn	Have the machine assessed and repaired by an authorised service technician

8 Spare parts

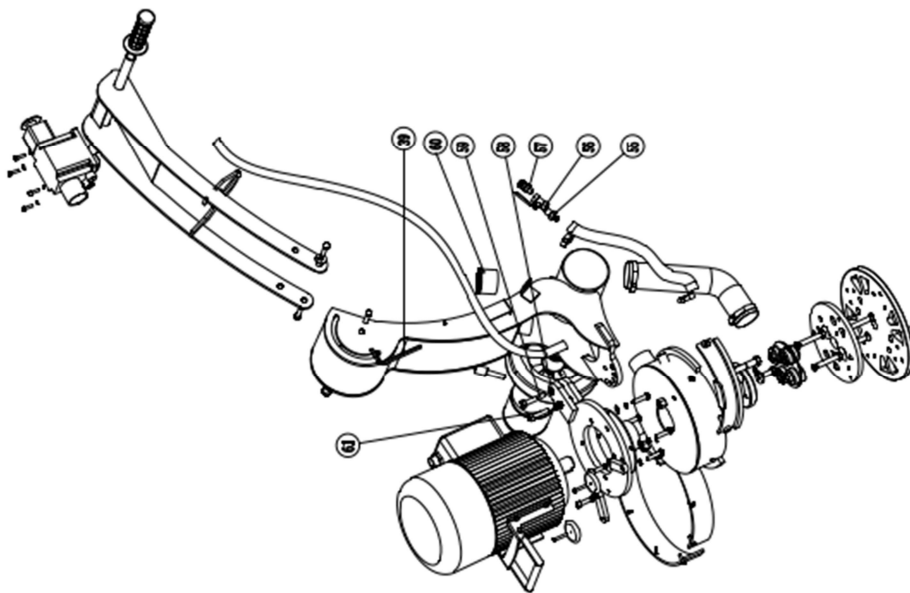
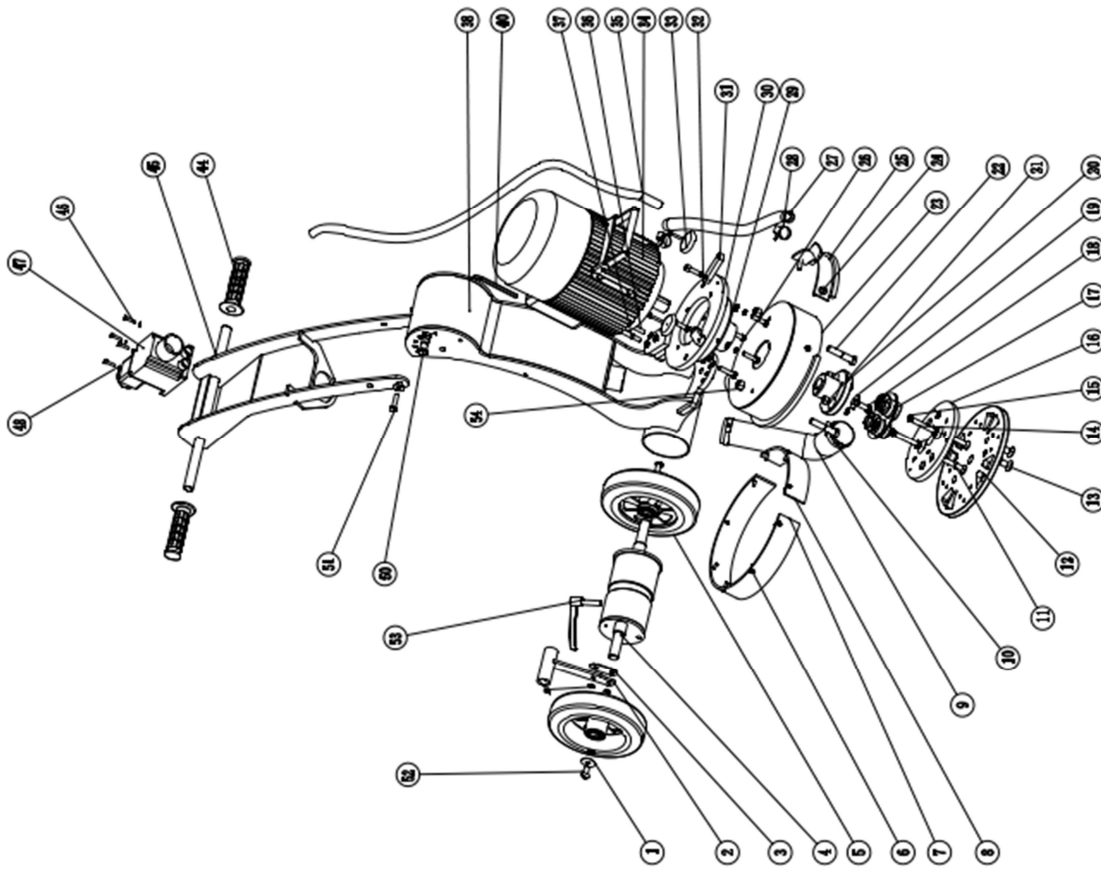

No.	Description of the	Quantity
1	Hexagon socket round head screw M10*20	2
2	Horizontal adjustment handle	1
3	Spacer	1
4	Axle	1
5	Wheel	2
6	Screw for dust cage	8
7	Long PVC dust cover	1
8	Short PVC dust cover	1
9	Hose	1
10	Steel strap	2
11	Hexagon head screw M10*55	2
12	Adapter plate (optional)	1
13	Hexagon countersunk screw M12*25	4
14	Hexagon countersunk screw M10*55	2
15	Flat gasket	2
16	Converter plate	1
17	Rubber coupling	1
18	Hexagon head screw M10*30	2
19	Flat gasket	1
20	Flange	1
21	Hexagon head screw M8*25	2
22	Hexagon head screw M10*30	2
23	Dust cover	1
24	Hexagon countersunk head screw M12*20	2
25	Removable upper bracket	1
26	Hexagon head screw M12*70	2
27	Fibre water hose	1
28	Quick coupling	1
29	Motor shaft sleeve	1

No.	Description of the	Quantity
30	Motor base plate	1
31	Fastening	2
32	Screw for corner wheel	2
33	Corner wheel	2
34	Engine	1
35	Cables	1
36	Hexagon head screws	2
37	Washer for spring washer	2
38	Centre hinged section	1
39	Hexagon socket spanner	1
40	Hexagon socket spanner	1
44	Rubber handle	2
45	Upper bracket	1
46	Screw for switch	4
47	Switches	1
48	Switch stop button	1
49	Upper snap frame	1
50	Adjusting screw	1
51	Screw with hexagon socket	2
52	Hexagon socket round head screw M10*20	2
53	Horizontal adjustment handle	1
54	Nut M12	2
55	O-ring	1
56	Mini valve	1
57	Quick connection	1
58	Smooth washer	2
59	Hexagon head screws	2
60	Vacuum hole cap	1
61	Screw with hexagon socket	1

9 EU Declaration of Conformity

The manufacturer/distributor

Kernlochbohrer GmbH
Geigersbühlweg 52
72663 Großbettlingen
Germany

hereby declares that the following product

Product description: **Floor grinding machine**

Type: **BSM-250/E-PRO**

complies with all relevant provisions of the applicable legal regulations (hereinafter) - including their amendments valid at the time of the declaration. This declaration of conformity is issued under the sole responsibility of the manufacturer. This declaration relates only to the machine in the state in which it was placed on the market; parts and/or modifications subsequently fitted by the end user are not taken into account.

The following legal provisions were applied:

Machinery Directive 2006/42/EU

Electromagnetic Compatibility Directive 2014/30/EU

The following harmonised standards were applied:

EN ISO 12100:2010 Safety of machinery - General principles for design - Risk assessment and risk reduction

EN 60204-1:2018 Safety of machinery - Electrical equipment of machines - Part 1: General requirements

Name and address of the person authorised to compile the technical documentation:

Kernlochbohrer GmbH
Geigersbühlweg 52
72663 Großbettlingen
Germany

Großbettlingen 27/02/2024

Kernlochbohrer GmbH

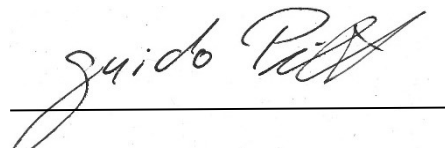

Guido Pillat

Managing Director / Chief Executive Officer