



Operating instructions

Water tank WT-60 | WT-60/S

BA-08-000001-02-EN

Scope of application

These Operating instructions only apply to the machine labelled on the cover sheet.

Check the model against the machine's rating plate.

Original instructions / translation of the original instructions

In accordance with the EU Machinery Directive, the German copy of these Operating instructions is the original instructions.

Copies in other languages are translations of the original instructions.

Kernlochbohrer GmbH

Geigersbühlweg 52

72663 Großbettlingen

Germany

Phone: +49 (0)70 22 / 50 34 900

E-mail: info@kernlochbohrer.com

Internet: <http://www.kernlochbohrer.com>

© Kernlochbohrer GmbH

This documentation is protected by copyright.

All rights to this documentation, in particular the right of reproduction, distribution and translation, are reserved by Kernlochbohrer GmbH, even in the case of applications for industrial property rights. No part of this documentation may be reproduced in any form by any means, electronic or mechanical, or processed, duplicated or distributed using electronic systems without the express written permission of Kernlochbohrer GmbH.

Subject to errors and technical changes.

Kernlochbohrer GmbH is not liable for any errors in this documentation. Liability for direct or indirect damages arising in connection with the delivery or use of this documentation is excluded to the extent permitted by law. Furthermore, Kernlochbohrer GmbH cannot be held liable for damages resulting from the infringement of patent and other rights of third parties.

The function of the machine is limited to the functions described in the associated technical documentation.

Table of contents

1	Information and support	6
1.1	Thanks to the buyer.....	6
1.2	Application of the Operating instructions.....	6
1.3	Changes	6
1.4	Explanation of symbols	7
1.5	Warranty	7
1.6	Environmental protection.....	7
1.6.1	Disposal of the packaging	7
1.6.2	Disposal of the product.....	8
1.7	Service	8
2	Safety	9
2.1	General information.....	9
2.2	Intended use.....	9
2.3	Safety instructions for the operator	10
2.3.1	Organisational safety measures	10
2.3.2	Modifications to the machine	10
2.3.3	Spare parts	11
2.3.4	Personnel.....	11
2.4	Safety regulations for personnel	12
2.4.1	Safe behaviour.....	12
2.4.2	Safe operation	13
2.4.3	Protective equipment.....	14
2.5	Safety during maintenance.....	15
2.5.1	General information	15
2.5.2	Cleaning.....	15
3	Technical data	16
3.1	WT-60.....	16
3.2	WT-60/S	17
4	Device description	18

4.1	Device components	18
4.2	Control panel	20
4.3	Scope of delivery	21
5	Use of the device	22
5.1	Specific precautions	22
5.2	Commissioning	23
5.3	Optical inspection	25
5.4	Filling the water tank	25
5.5	Establishing the power supply	26
5.5.1	Operation with mains voltage	26
5.5.2	Operation with rechargeable battery	27
5.6	Switch on the water tank	28
5.7	Switch off the water tank	29
6	Spare parts	30
7	EU Declaration of Conformity	32

1 Information and support

1.1 Thanks to the buyer

Thank you for purchasing a machine from Kernlochbohrer GmbH.

Please read the Operating instructions carefully and observe the safety instructions. By following the Operating instructions, you will be able to fully utilise the outstanding performance of our product.

If you have any questions regarding the operation of the machine, please contact Kernlochbohrer GmbH directly. We are available to answer your questions at any time.

1.2 Using the Operating instructions

The machine is intended for professional use and may only be operated by trained personnel. Strictly adhere to the instructions in the Operating instructions.

Our company declines all responsibility in the event of non-compliance with the Operating instructions, which may result in injury or damage to property.

The Operating instructions are indispensable for using the machine. The Operating instructions must therefore always be kept close to the machine and be accessible to the intended personnel at all times.

In addition to the Operating instructions, the generally applicable and local regulations for accident prevention and environmental protection must be provided; compliance with these regulations must be checked regularly.

1.3 Changes

Kernlochbohrer GmbH reserves the right to change the design and appearance of the products and their Operating instructions. Future changes to the Operating instructions will be made without prior notice.

1.4 Explanation of symbols



The symbol draws your attention to dangers that you must be aware of when carrying out the following work in order to avoid injury to yourself, other persons or damage to property.



Cross-reference to another point in the Operating instructions.



Prerequisite for an action.



Action to be performed.



Behaviour of the machine that is to be expected as a result of the preceding action.



Background information or reference to special features.

1.5 Guarantee

In accordance with Kernlochbohrer GmbH's general terms and conditions of delivery, a warranty period of 12 months applies to material defects in business transactions with companies (proof by invoice or delivery note).

Damage caused by natural wear and tear, overloading or improper handling is excluded.

Damage caused by material or manufacturer defects will be rectified free of charge by repair or replacement. Complaints can only be recognised if the device is sent to Kernlochbohrer GmbH undismantled.

Wear parts are excluded from the warranty.

1.6 Environmental protection

1.6.1 Disposal of the packaging

The packaging is made from recyclable materials. They must be disposed of in accordance with their labelling and municipal guidelines.

1.6.2 Disposal of the product

Follow national regulations on environmentally friendly disposal and recycling of used machines and accessories.

For EU countries only:

Do not dispose of the machine with household waste! In accordance with European Directive 2012/19/EU on waste electrical and electronic equipment and its transposition into national law, used power tools must be collected separately and recycled in an environmentally friendly manner.

1.7 Service

Precise information and specific questions allow faults to be rectified quickly, make it easier to order spare parts and prevent incorrect deliveries.

Before contacting the service, please collect the following data first.

The model designation must be stated in all enquiries and orders. This information can be found on the rating plate of the machine.

Further information is required in the event of faults:

Type and extent of the disorder, accompanying circumstances, suspected cause.

This is required when ordering spare parts:

Quantity and item number in the exploded view of these Operating instructions or item number (if known).

- ① You are welcome to send us photos when ordering spare parts or videos in the event of faults.

Contact details:

Kernlochbohrer GmbH

Geigersbühlweg 52

72663 Großbettlingen

Germany

Phone: +49 (0)70 22 / 50 34 900

E-mail: info@kernlochbohrer.com

Internet: <http://www.kernlochbohrer.com>

2 Security

2.1 General information

The machine was built according to the state of the art and in compliance with the applicable laws, standards and safety regulations. Nevertheless, the use of the appliance may pose a risk to the user or third parties and cause damage to the machine and other property.

The machine may only be used if it is in perfect working order and in accordance with its intended use and in a safe and hazard-conscious manner.

If the machine is damaged or malfunctions, take it out of operation immediately, secure it against use and repair it or arrange for it to be repaired.

2.2 Intended use

The machine is intended exclusively for supplying water to power tools used for wet machining processes. These can be Core drilling machines or floor grinders, for example.

The machine may only be used within the limits of its technical data. This information, for example performance data and ambient conditions, can be found in the "Technical data" chapter.

Any other or additional use is considered improper use - risk of accident!
Kernlochbohrer GmbH is not liable for any resulting damage. The risk is borne solely by the operator.

Intended use also includes observing the operating instructions and complying with the prescribed maintenance intervals.

2.3 Safety regulations for the operator

2.3.1 Organisational safety measures

The Operating instructions must always be available for the operating and maintenance personnel. It must therefore always be kept at the machine's place of use.

The regulations on accident prevention and environmental protection applicable at the place of use of the machine must also be available. The operator of the machine must regularly check compliance with these regulations.

The use of sound-emitting machines may be limited in time by national or local regulations.

The machine must not be operated in potentially explosive atmospheres or in the vicinity of flammable liquids, gases or combustible dust.

All safety and danger notices on the machine must be legible and must not be removed.

The protective equipment required to operate the machine must be provided by the operator. The operator must ensure that the protective equipment is used properly by the personnel.

Operating and auxiliary materials, such as lubricants or cleaning agents, must be selected in such a way that the limit values for hazardous substances applicable at the place of use are complied with. The regulations for environmental protection and disposal applicable at the place of use must be complied with.

2.3.2 Changes to the machine

The operator may not make any modifications to the machine without written authorisation from Kernlochbohrer GmbH. If the operator carries out modifications without authorisation, the warranty becomes void. Kernlochbohrer GmbH is not liable for damage caused by unauthorised modifications.

2.3.3 Spare parts

Spare parts must comply with the properties defined by Kernlochbohrer GmbH. This is always guaranteed for spare parts supplied by Kernlochbohrer GmbH. Kernlochbohrer GmbH is not liable for damage caused by the use of unsuitable spare parts.

2.3.4 Personnel

All persons who are authorised to commission, operate and maintain the machine must have read and understood the Operating instructions beforehand.

The machine may only be operated by persons who have been adequately instructed beforehand.

The machine may only be serviced by persons who have completed the appropriate specialised training for this activity.

Minors are not permitted to work with the machine. Young people over the age of 16 who are trained under supervision are exempt from this regulation.

2.4 Safety regulations for staff

2.4.1 Safe behaviour

All persons responsible for commissioning, operating and maintaining the machine must have read and understood the Operating instructions beforehand.

The machine may only be operated by persons who have been adequately instructed beforehand.

The machine may only be serviced by persons who have completed the appropriate specialised training for this activity.

Minors are not permitted to work with the machine. Young people over the age of 16 who are trained under supervision are exempt from this regulation.

Any work on and with the machine that could jeopardise safety must be avoided.

All safety and danger notices on the machine must be legible and must not be removed.

2.4.2 Safe operation

Operating the machine requires the full concentration and ability of the personnel. Persons who are overtired, unable to concentrate or under the influence of alcohol, drugs or medication must not work on or with the machine.

Persons who are not directly required to operate the machine must maintain a sufficient safety distance from the appliance.

Before using the machine, check that it is in perfect condition. If the machine is damaged, it must not be used. Then secure the machine against use and repair it or arrange for it to be repaired.

In order not to jeopardise the functionality and safety of the machine, covers or other components of the machine must not be removed.

Before starting or starting up the machine, ensure that persons are not endangered by the starting machine.

Operating elements must not be operated thoughtlessly or wilfully. This could result in personal injury or damage to the appliance.

When using the machine, personnel must ensure that they stand securely and adopt an ergonomic posture.

The machine must not be left unattended during use.

Air inlet and outlet openings must not be covered during use.

Never immerse the machine in water.

The machine must be cleaned regularly so that dirt does not accumulate. All operating elements and handles must be kept clean, dry and free of grease.

When the machine is not in use, it must be parked in such a way that nobody is endangered. Secure the machine against unauthorised use.

2.4.3 Protective equipment

Wearing protective equipment reduces the risk of injury:

- Safety shoes with non-slip sole and protective toe cap
- Cut-resistant and non-slip gloves
- Safety goggles according to standard EN 166 or face protection
- Safety helmet

If the noise emissions generated when using the appliance exceed the limits applicable to this workplace, suitable hearing protection must be worn.

Persons carrying out maintenance work on the appliance are obliged to wear the appropriate protective equipment required for this work.

2.5 Safety during maintenance

2.5.1 General information

The machine may only be serviced by persons who have completed the appropriate specialised training for this activity.

The maintenance activities and intervals specified in the Operating instructions must be observed.

Workshop equipment appropriate to the type of work is required to carry out maintenance activities.

The following safety precautions must be taken before starting maintenance work:

- Position the machine so that the access point is easily accessible.
- Set the machine to the appropriate operating status.

After completion of maintenance activities:

- Assemble the machine completely.
- If operating elements or safety devices have been removed, they must be refitted and their function checked.

Persons carrying out maintenance work on the machine are obliged to wear the appropriate protective equipment required for this work.

2.5.2 Cleaning

Do not use any corrosive, harmful or environmentally damaging substances to clean the machine. Dispose of cleaning agents in an environmentally friendly manner.

Under no circumstances should high-pressure cleaners, water jets or compressed air be used to clean the machine.

3 Technical data

3.1 WT-60

- ① The WT-60 water tank corresponds to the WT-60/S water tank, but does not have a hose reel.

Article number	6270
Container volume	60 litres
Pump	Flow rate Dynamic pressure Tension
	12.5 litres/min 2.4 bar 12 V DC
Width	500 mm
Depth	480 mm
Height	915 mm
Weight	19 kg
Supply voltage	230 V \pm 5%
Frequency	50 Hz
Rated power	55 W
Maximum power	100 W
Mains plug	Type F (CEE7/4)
Mains cable length	3 m
Battery compatibility	Bosch Professional 18V (AMP Share)
Water hose cross-section	D = 18 mm / d = 12 mm
Water hose length	3 m
Hose connection	Gardena plug-in system
Permissible ambient temperature	5°C to 40°C
Permissible relative humidity	30% to 80%

3.2 WT-60/S

- ① The WT-60/S water tank is the same as the WT-60 water tank, but also has an attachable hose reel.

Article number	6271
Container volume	60 litres
Pump	Flow rate Dynamic pressure Tension
	12.5 litres/min 2.4 bar 12 V DC
Width	500 mm
Depth	720 mm
Height	915 mm
Weight	23 kg
Supply voltage	230 V $\pm 5\%$
Frequency	50 Hz
Rated power	55 W
Maximum power	100 W
Mains plug	Type F (CEE7/4)
Mains cable length	3 m
Battery compatibility	Bosch Professional 18V (AMP Share)
Water hose cross-section	D = 18 mm / d = 12 mm
Water hose length	10 m
Hose connection	Gardena plug-in system
Permissible ambient temperature	5°C to 40°C
Permissible relative humidity	30% to 80%

4 Device description

4.1 Device components



- 1 Filler opening cover
- 2 Connection socket for mains cable (on the side)
- 3 Fastening thread (6 pieces) for hose reel of the WT-60/S
- 4 Water tank
- 5 Wheel (2 pieces)
- 6 Mains cable
- 7 Handle
- 8 Hose connection
- 9 Water hose
- 10 Drain plug of the water tank

Only for WT-60/S:



- 1 Hose reel with hose
- 2 Fastening set

4.2 Control panel

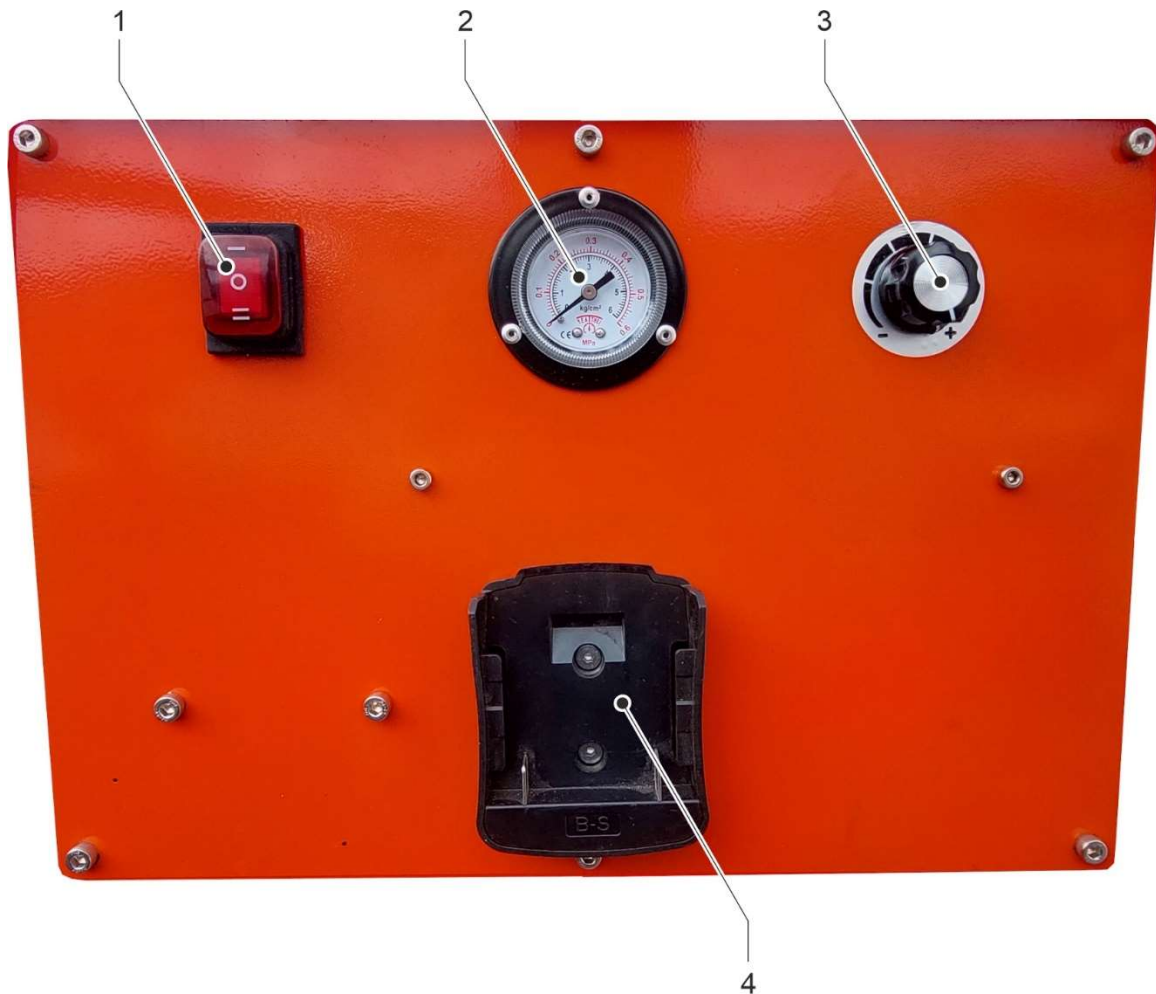

- 1 Main switch
- 2 Pressure gauge
- 3 Pressure regulator
- 4 Battery holder

① Note on the pressure gauge:
0.1 MPa = 1 kg/cm² = 1 bar

4.3 Scope of delivery

- ① The accessories are located in the water container of the water tank on delivery.
- For removing the accessories:
Unscrew the lid of the filler opening, remove the filler sieve and remove the accessories.
Then insert the filler sieve and attach the lid.

The scope of delivery includes the following components:

- Water tank
- Wheel set, consisting of:
 - 2 Wheel
 - 4 Disc
 - 2 Split pin
- Mains cable
- Water hose
- Hose reel (only for WT-60/S)
- Fastening set for hose reel (only for WT-60/S)
- Operating instructions

- ① Kernlochbohrer GmbH offers an extensive range of machines, tools and accessories. The webshop <http://www.kernlochbohrer.com> is available for information and ordering.

5 Use of the device

5.1 Specific precautions



The water container of the water tank may only be filled with clean water (preferably of drinking water quality)!

Contaminated water can damage the pump.

The water tank must not be filled with corrosive, aggressive or flammable liquids!



To prevent negative pressure in the water tank during operation, a ventilation element is installed on the cover of the filler opening.

The pressure equalisation in the water tank must not be impaired by a covered, dirty or damaged ventilation element, as otherwise the pump or the water tank could be damaged.



- 1 Filler opening cover
- 2 Ventilation element

5.2 Commissioning

The supplied wheel set must be fitted before working with the water tank.

The wheel set elements must be fitted as follows on each side of the axle attached to the water tank:

- A Fit the first disc on the axle. Note the orientation of the disc.
- B Attach the wheel to the axle.
- C Fit the second disc. Note the orientation of the disc.
- D Insert the split pin through the axle and bend the ends.

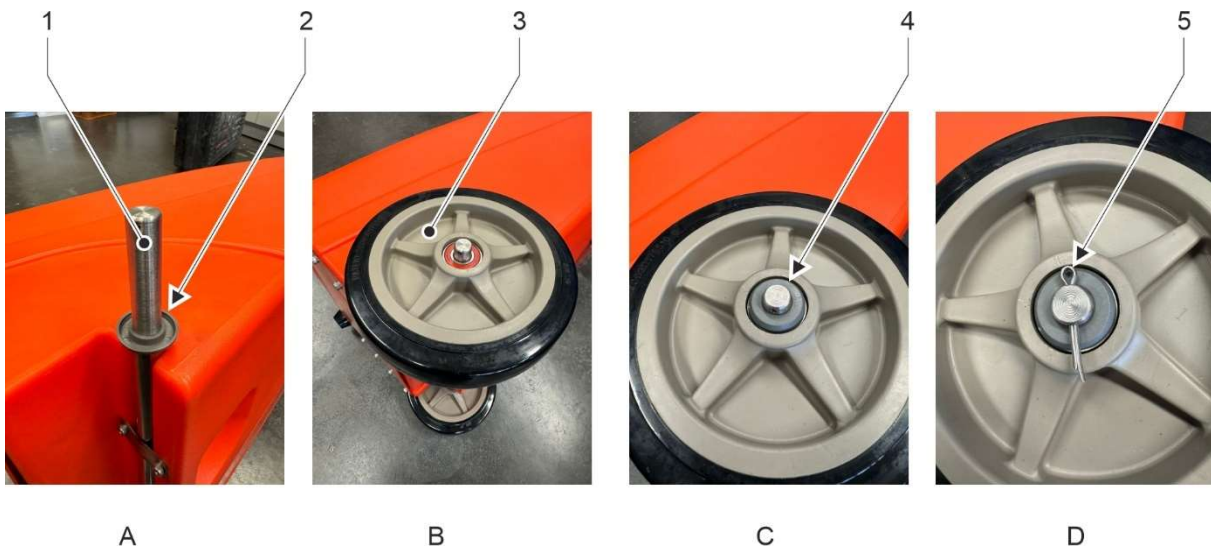

- 1 Axle
- 2 First disc
- 3 Wheel
- 4 Second disc
- 5 Split pin (ends not yet bent here)

- ① The water tank can now be tilted backwards for transport and pushed on its wheels.

Attachment of the hose reel (only for WT-60/ S):

- ① The six fastening threads on the front of the water tank are used to mount the hose reel.

- ☒ Attach the upper retaining clip to the water tank using four cylinder screws.
- ☒ Attach both lower retaining clips to the water tank using the cheese head screw.
- ☒ Insert the hose reel into the retaining clips and engage by applying gentle pressure.
- ☒ Attach the connecting hose from the hose connection of the water tank to the inlet of the hose reel.

5.3 Optical inspection

Before working with the water tank, it must be visually inspected:

- Check general condition and cleanliness.
- Check that all covers and components are present.
- Check that all screws are tight.
- Ventilation on the lid of the filler opening is functional.



The water tank may only be operated if the water tank is properly ventilated.

5.4 Filling the water tank

Procedure:

- Visual inspection carried out.
- Water tank switched off at the main switch.
- Place the water tank on a level and horizontal surface.
- Unscrew the lid of the filler opening.
- Fill the water tank with clean water.
 - ① The water tank can be filled up to the thread of the filler opening.
- Remove the filler sieve from the filler opening and clean it.
- Insert the filler sieve.
- Attach the filler opening cover.

5.5 Establish power supply

5.5.1 Operation with mains voltage

The following points must be observed when connecting the water tank to an AC power supply:

- Observe the electrical connection values of the water tank.
 See chapter 3 "Technical data".
- The mains cable and mains plug must not be damaged.
- Damaged mains cable or damaged mains plug may only be replaced by Kernlochbohrer GmbH or a qualified electrician.
- Plug the mains cable into the connection socket of the water tank.
- The water tank is equipped with a type F mains plug (CEE 7/4). The water tank may only be operated from a grounded socket outlet (CEE 7/3) that is appropriately earthed.
- When connecting the water tank to the mains, a residual current circuit breaker with a maximum tripping current of 30 mA must be connected upstream.
- The vacuum cleaner may only be connected to a socket outlet that is protected by a circuit breaker or a fuse with a minimum current rating of 16 A.
- Never touch the mains plug with wet hands.
- The mains plug and socket must be clean and dust-free.
- The electrical voltage supplied must not deviate by more than 5% from the nominal value. Excessive voltages can lead to irreparable damage to the water tank.
- Voltage peaks must not occur when operating the water tank with power generators.
- When using extension cables, the cable cross-section must be suitable for the power consumption of the water tank.
- When using a cable reel, the cable must always be unrolled completely.
- Grasp the mains plug to remove the mains cable from the socket. Do not pull on the cable.
- If the water tank is not to be used for a longer period of time, switch off the water tank and remove the mains plug from the socket.

5.5.2 Operation with rechargeable battery

The following points must be observed when operating the water tank with a "Bosch Professional 18V" rechargeable battery:

- Only rechargeable batteries that are suitable for the water tank may be used.
 See chapter 3 "Technical data".
- The battery and the battery holder on the water tank must be clean, dust-free and dry.
- Insert the charged battery into the battery holder on the water tank and click into place.
- At the end of the work: Remove the battery from the battery holder.
- To remove the battery, press the battery release button on the battery and remove the battery. Do not use force.



Further information and safety instructions can be found in the operating instructions for the battery and the battery charger.

5.6 Switch on the water tank

Procedure:

- ☑ Visual inspection carried out.
- ☑ Water tank filled.
- ☑ Power supply established.
- ☒ Connect the water hose to the hose connection of the water tank.
- ☒ Connect the free end of the water hose to the consumer. If necessary, close the stopcock on the consumer to prevent water from leaking.
- ☒ Switch on the water tank pump at the main switch:
 - Position I: Power supply with mains voltage.
 - Position II: Power supply from battery.
- ☞ The water tank pump starts pumping water into the water hose.
- ☒ Once a continuous flow of water to the consumer has been established, the desired water pressure can be set using the pressure regulator.

The pressure gauge displays the water pressure.

 - ① The water pressure should be set as low as possible.

High water pressure requires more energy; in battery mode, high pressure reduces the running time.
 - ① If no water is required at the consumer, switch off the water tank pump at the main switch. This saves energy and protects the pump.
- ☒ When the water tank is empty:
 - Switch off the water tank pump at the main switch.

Position 0: Power supply to the water tank switched off.

 - ① The pump is safe to run dry. Nevertheless, the water tank should be switched off when the water tank is empty. This saves energy and protects the pump.
 - Refill the water tank.

 See chapter 5.4 "Filling the water tank".

5.7 Switch off the water tank

Procedure:

- Consumer no longer needs water.
- Switch off the water tank pump at the main switch.
- For power supply with mains voltage:
 - Remove the mains plug from the socket.
 - Remove the mains cable from the connection socket on the water tank.
 - Wind up the mains cable.
- For power supply with rechargeable battery:
 - Remove the battery from the battery holder.
 - Charge the battery with a suitable charger.
 - Store the battery protected from heat, sunlight, dirt, water and moisture.
- Remove the water hose from the hose connection of the water tank and from the consumer.

Empty the water hose completely and wind it up.
- If the water tank is not to be used for a longer period of time, the water tank must be emptied:
 - Place the water tank on a suitable drain.
 - Remove the lid of the filler opening.
 - Remove the drain plug from the water tank.
 -  Water tank is running empty.
 - Fit the drain plug and cover.
- Check the outer surface of the water tank and the inside of the water tank for soiling. Clean if necessary.
- Allow the water tank to dry out completely. Then fit the filler opening cover.
- Place the water tank vertically and secure it against falling over.
- Store the water tank in a dry, cool place protected from moisture and direct sunlight.
- Secure the water tank against unauthorised use.

6 Spare parts

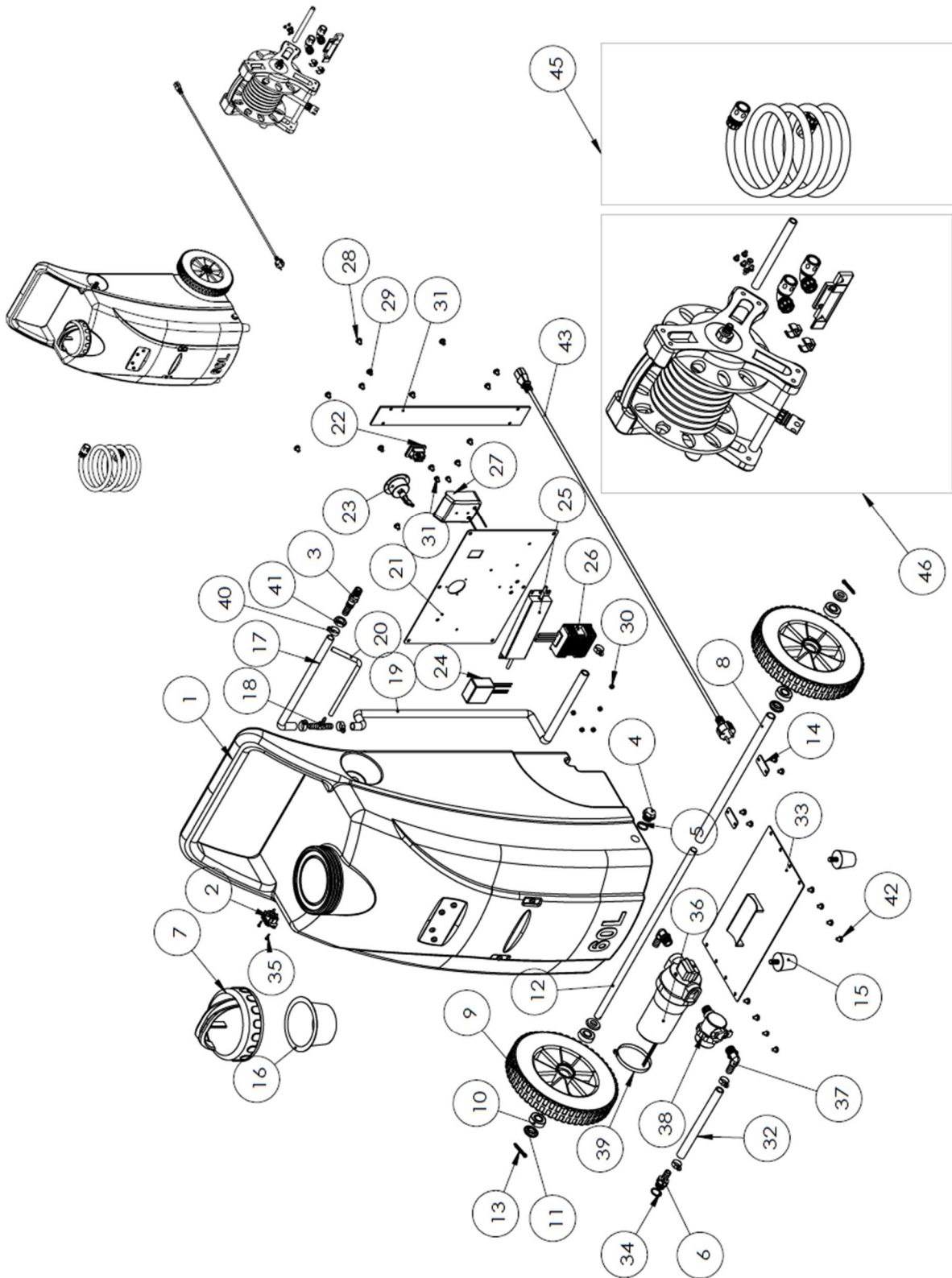

Pos.	Designation
1	Tank
2	Plug-in base
3	Plug
4	Screw plug
5	Sealing ring
6	Straight nozzle
7	Lid filler opening
8	Pipe
9	Wheel
10	Warehouse
11	Disc
12	Axle
13	Pen
14	Plate
15	Foot
16	Filling sieve
17	Hose
18	T-spigot
19	Hose
20	Hose
21	Plate
22	Main switch
23	Pressure gauge
24	Pressure regulator

Pos.	Designation
25	Voltage transformer
26	Direct current transformer
27	Battery holder
28	Screw
29	Screw
30	Mother
31	Metal piece
32	Hose
33	Pump plate
34	Sealing disc
35	Screw
36	Pump
37	Corner spigot
38	Filters
39	Clamping ring
40	Clamping ring
41	Mother
42	Screw
43	Mains cable
45	Hose set 3 m (only for WT-60)
46	Hose set 10 m (only for WT-60/S)

7 EU Declaration of Conformity

The manufacturer/distributor

Kernlochbohrer GmbH
Geigersbühlweg 52
72663 Großbettlingen
Germany

hereby declares that the following product

Product description: **Water tank**
Type: **WT-60 | WT-60/S**

complies with all relevant provisions of the applicable legal regulations (hereinafter) - including their amendments valid at the time of the declaration. This declaration of conformity is issued under the sole responsibility of the manufacturer. This declaration relates only to the machine in the state in which it was placed on the market; parts and/or modifications subsequently fitted by the end user are not taken into account.

The following legal provisions were applied:

Machinery Directive 2006/42/EU

The following harmonised standards were applied:

EN 60204-1: 2018	Safety of machinery - Electrical equipment of machines - Part 1: General requirements
EN ISO 12100:2018	Safety of machinery - General principles for design - Risk as- sessment and risk reduction

Name and address of the person authorised to compile the technical documentation:

Kernlochbohrer GmbH
Geigersbühlweg 52
72663 Großbettlingen
Germany

Großbettlingen 2025-07-27

Core Hole Drill GmbH

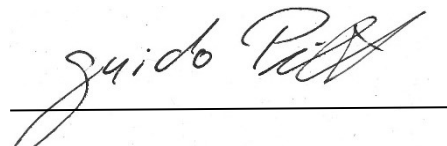

Guido Pillat
Managing Director / Chief Executive Officer